

SECTION 4 CHARTS AND DIAGRAMS

4.1 SECAM CIRCUIT BOARD

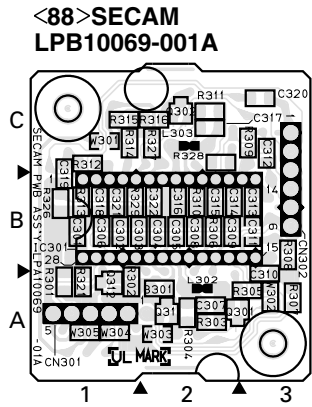

COMPONENT PARTS LOCATION GUIDE <SECAM >

REF.NO.	LOCATION	REF.NO.	LOCATION	REF.NO.	LOCATION	REF.NO.	LOCATION	REF.NO.	LOCATION
CAPACITOR		C313	B C 2B	IC		RESISTOR		R313	B C 1B
C301	B C 1B	C314	B C 2B	IC301	A D 1B	R301	B C 1A	R314	B C 1C
C302	B C 1B	C315	B C 2B	COIL		R302	B C 1A	R315	B C 1C
C303	B C 1B	C316	B C 2B	L302 A D 2A L303 A D 2C		R303	B C 2A	R316	B C 2C
C304	B C 2B	C317	B C 2C			R304	B C 2A	R321	B C 1A
C305	B C 2B	C318	B C 1B	TRANSISTOR		R305	B C 2A	R326	B C 1B
C306	B C 1B	C319	B C 1B	Q301	B C 2A	R306	B C 2B	R327	B C 2C
C307	B C 2A	C320	B C 3C	Q302	B C 2C	R307	B C 3A	R328	B C 2B
C308	B C 2B	C321	B C 1B	Q311	B C 2A	R308	B C 3B	R329	B C 1B
C309	B C 2B	C322	B C 2B	Q312	B C 1A	R309	B C 2C		
C310	B C 3A	CONNECTOR				R310	B C 2B		
C311	B C 2B	CN301	A D 1A			R311	B C 2C		
C312	B C 3C	CN302	A D 3C			R312	B C 1B		

4.2 WAVEFORMS

< SECAM >

WF1 CN301-1
PB_COLOR

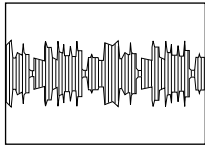

SECAM PB 0.44 Vp-p
20 mV/20 μsec/DIV

WF2 CN301-2
V_TO_SECAM

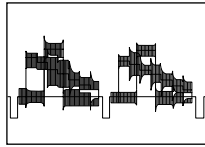

SECAM REC/PB 2.4 Vp-p
50 mV/20 μsec/DIV

WF3 CN302-4
REC_COLOR

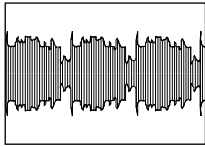

SECAM REC 0.44 Vp-p
10 mV/20 μsec/DIV

WF4 CN302-5
PB_FM

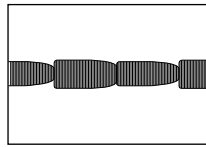

SECAM PB 0.36 Vp-p
20 mV/1 msec/DIV

4.3 SECAM SCHEMATIC DIAGRAM

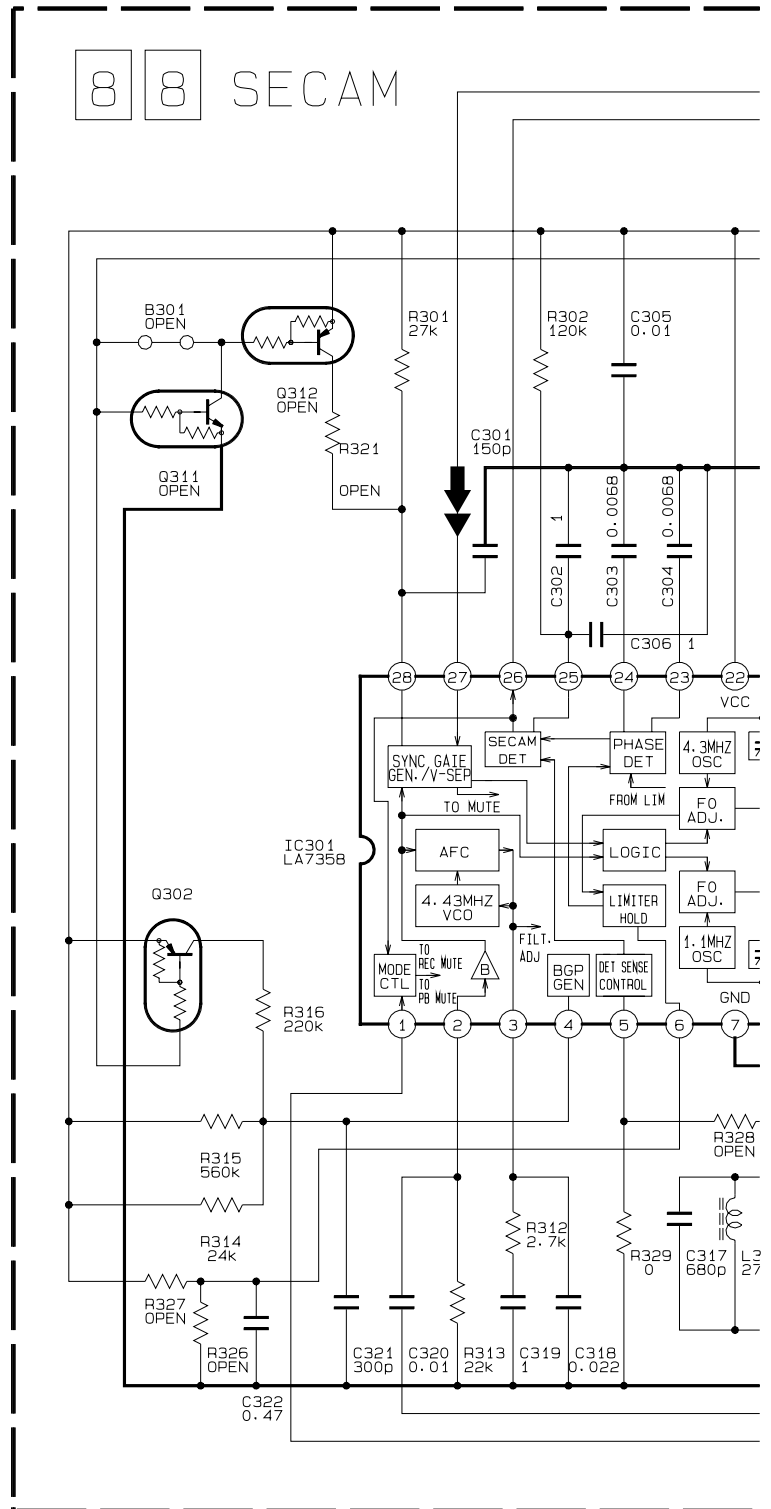

Note : For the waveforms in this schematic diagram, refer to page 4-1.

NOTES: UNLESS OTHERWISE SPECIFIED.
 ALL RESISTANCE VALUES ARE IN OHMS.
 ALL INDUCTANCE VALUES ARE IN H.
 ALL CAPACITANCE VALUES ARE IN μ F.

- ELECTROLYTIC
- CERAMIC
- MYLER
- NON POLAR

Note : The Parts Number, value and rated voltage etc. in the Schematic Diagram are for references only.
When replacing the parts, refer to the Parts List.

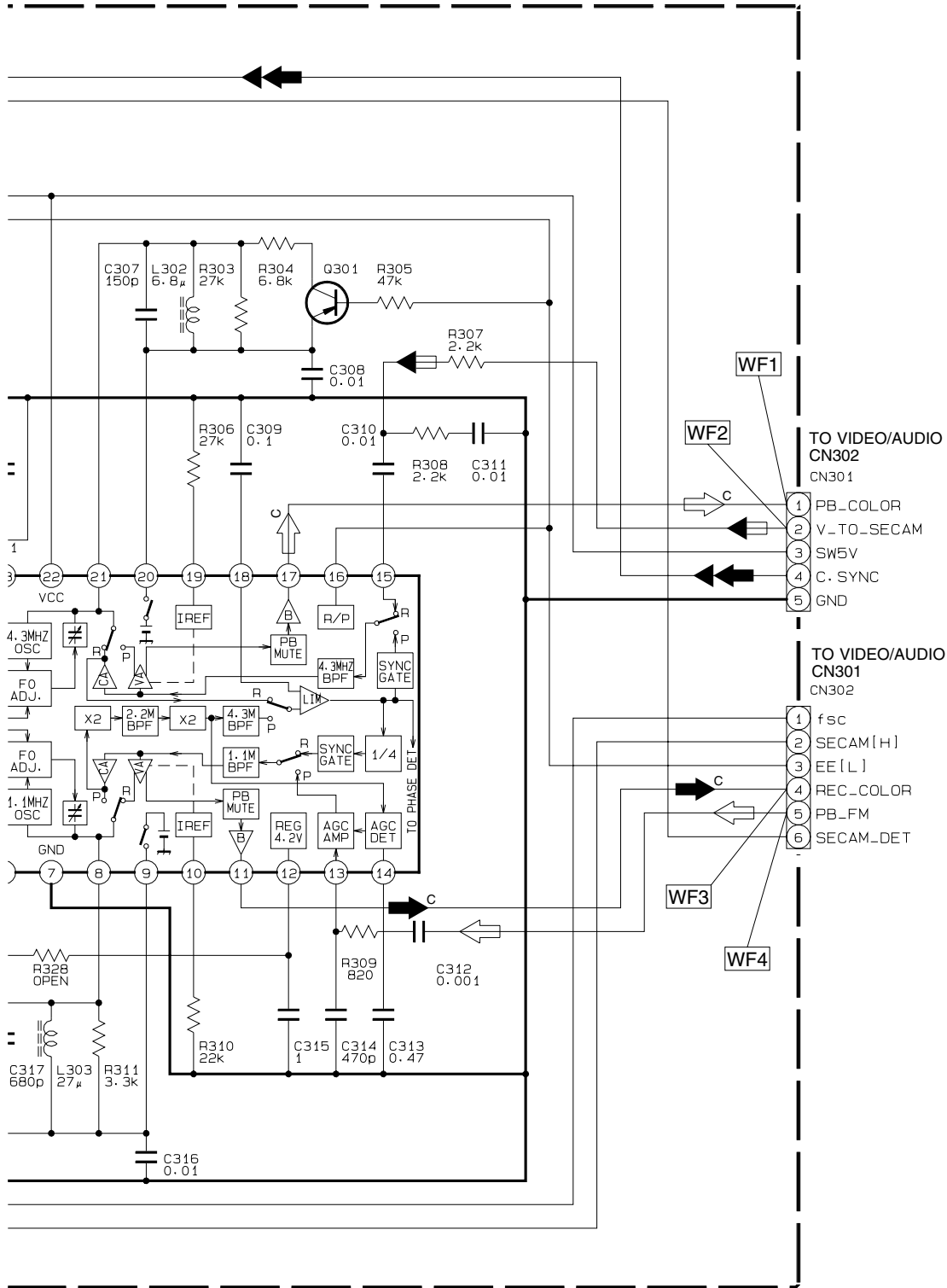

p30054001a_rev0

